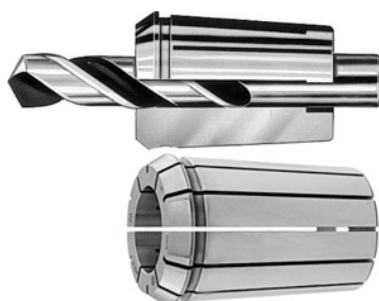

**FAHRION®**  
PRAZISION
**OZ collet for chuck, 2 # 25 mm, Nominal clamping Ø d: 24 mm**

**Order data**

Order number	309550 24
GTIN	2050001704696
Item class	39Y

**Description**
**Version:**

Spring steel, through hardened and ground. The through bore (longer clamping range than DIN collets) increases the clamping force. More slits than DIN collets, giving a greater insertion depth in the collet chuck. Suitable for jobber drills, for clamping on the guide land **Clamping range = Nominal size down to minus 0.5 mm.** 5 or 6 slits each end.

**Advantage:**

- **Better radial run-out = axially parallel centring in taper; no tumbling.**
- **Higher clamping force = due to improved grip.**
- **Higher system stiffness = suitable for high-speed milling.**
- **Longer tool life.**

Standard: ISO 10897

Overall length L: 52 mm

**Technical description**

Nominal clamping Ø d	24 mm
for chuck	2 - 25 mm
Product name attribute	2 # 25 mm
Standard	ISO 10897

Type	462 E
External Ø D	35.05 mm
Overall length L	52 mm
Type of product	Clamping head