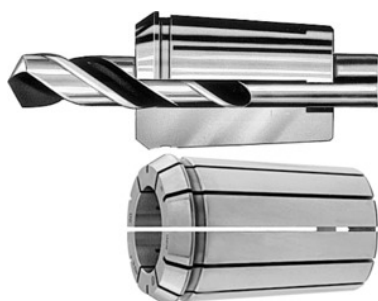

FAHRION®
PRAZISION
OZ collet for chuck, 4 # 32 mm, Nominal clamping \varnothing d: 10 mm

Order data

Order number	309560 10
GTIN	2050001704719
Item class	39Y

Description
Version:

Spring steel, through hardened and ground. The through bore (longer clamping range than DIN collets) increases the clamping force. More slits than DIN collets, giving a greater insertion depth in the collet chuck. Suitable for jobber drills, for clamping on the guide land **Clamping range = Nominal size down to minus 0.5 mm.** 5 or 6 slits each end.

Advantage:

- **Better radial run-out = axially parallel centring in taper; no tumbling.**
- **Higher clamping force = due to improved grip.**
- **Higher system stiffness = suitable for high-speed milling.**
- **Longer tool life.**

Standard: ISO 10897

Overall length L: 60 mm

Technical description

Nominal clamping \varnothing d	10 mm
for chuck	4 - 32 mm
Product name attribute	4 # 32 mm
Standard	ISO 10897

Type	467 E
External Ø D	43.7 mm
Overall length L	60 mm
Type of product	Clamping head